



HITZE

LUPO / LEGNO
Freestanding stoves



Hitze Ltd. is a Polish manufacturer of modern and ecological steel fireplace inserts, pellet and freestanding stoves, biofireplaces and fireplace accessories, as well as garden hearths.

The wide product range is characterized by diversified heating power, low emission of exhaust gases and modern design. The company has been supplying products of the highest quality to the Polish and foreign markets, made using the latest technologies. A qualified team of specialists, modern machine park and forty years of experience in the steel industry support the company.

The Hitze brand products have international certificates confirming their technical parameters, meeting strict emission standards and the European ECODSIGN directive. The dynamic development of the company and cooperation with the best partners allows us to constantly expand the distribution network and the product offer as well as maintain a stable position on the market. In 2017, the company's products were available in 25 countries around the world.



Freestanding stoves from the LUPO line are modern, ecological and functional devices that are ideally suited as a source of heat in summer houses or tenement houses.

The modular basis, depending on the needs and preferences of the arrangement, gives four variants of the housing assembly. Depending on the location of the stove in the room, combustion gases can be discharged to the chimney from the outlet on the back or top wall. They also give back the heat with their whole surface by the exhaust pipe to the chimney. In addition, warm air can be distributed to other rooms (HAD).

The interior of the stove is lined with the warmth accumulating chamotte. Heat-resistant glass in the door allows to control the condition of the hearth and observe the burning fire. Stoves are available in three sizes, powers, and colors.

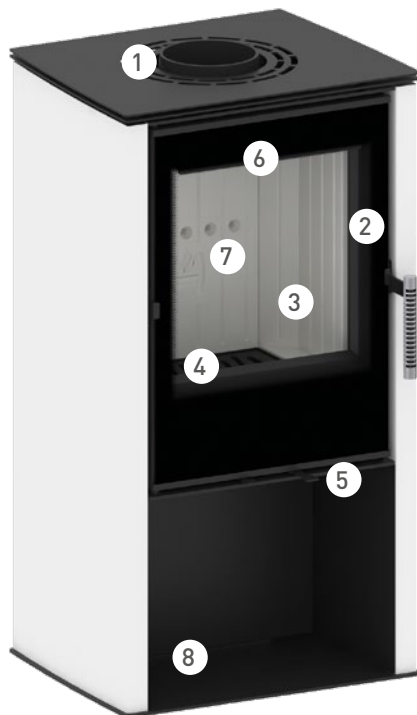





- 1 Cast iron flue
possibility of mounting
on the top or back wall.
- 2 Decor glass pane
- 3 Combustion chamber
lined with material
accumulating warmth..
- 4 Cast iron grate
- 5 Double throttle
independent air control
primary and secondary.
- 6 Clean glass system
optimal air circulation reduces
soot deposition on the glass pane.
- 7 The after-burning system
increases thermal energy volume.
- 8 Modular basis
four assembly variants.





LUPO S freestanding stove



-  6,5 kW
-  3 kW - 8,5 kW
-  83 %
-  492x938x400 mm



A+

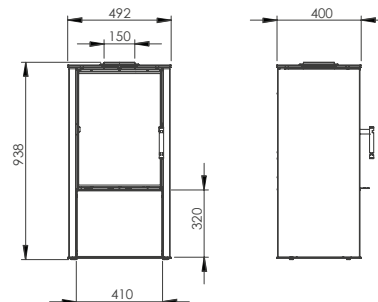

LUPO M freestanding stove



-  8,7 kW
-  4 kW - 11 kW
-  82 %
-  647x938x400 mm



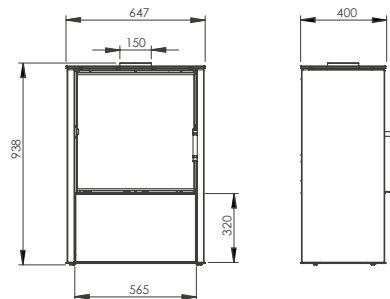

A+



LUPO L freestanding stove



-  11,0 kW
-  5,5 kW - 14 kW
-  82 %
-  982x938x400 mm



A+

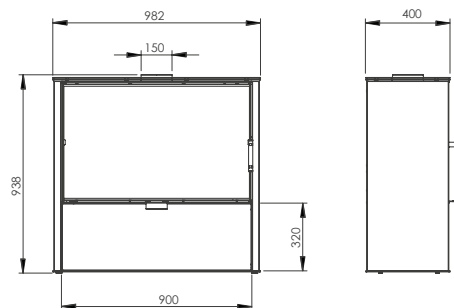

Legno freestanding stove gives reliability and comfort of everyday smoking.

It is a product for customers who pay attention to traditional solutions such as cast iron grate, cast iron flue and ash drawer, which is available directly from the front of the stove. At the same time, the design of the product refers to the popular industrial style.

Innovative technological approach using the largest steel elements and their multifaceted bending allowed to achieve exceptional durability of the stove.

The small size of the product is ideal for situations where we want to save space. On the other hand, a wide range of heating power from 2 to 7 kW makes the stove attractive also for those who look for a constant and effective source of heating for many years.



- 1** Cast iron flue
possibility of mounting
on the top or back wall.
- 2** Clean glass system
provides the air curtain
and air steering.
- 3** Combustion chamber
lined with material
accumulating warmth.
- 4** Cast iron grate
with independent aeration.
- 5** Double throttle
independent air control
primary and secondary.
- 6** Traditional ash drawer
available directly from the front of the stove.





LEGNO
freestanding stove



	5,5 kW
	2,5 kW - 7 kW
	78 %
	385x897x350 mm

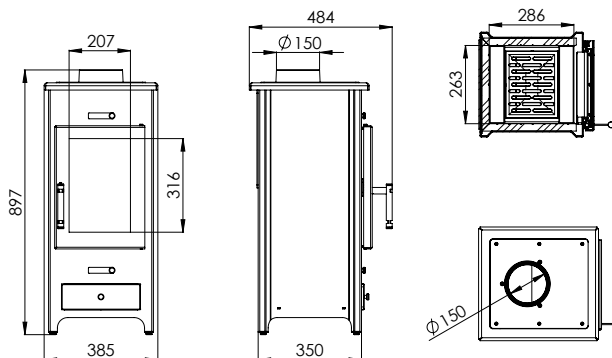

FREESTANDING STOVES

	LUPO S	LUPO M	LUPO L	LEGNO
Nominal power [kW]	6,5	8,7	11,0	5,5
Heating load range [kW]	3-8,5	4-11	5,5-14	2,5-7
Thermal efficiency [%]	83	82	82	78
CO emission (at 13% O ₂) [g/m ³]	1,080	1,001	0,921	1,137
Dust emission [g/m ³]	0,038	0,033	0,028	0,035
Exhaust temperature [°C]	239	235	230	220
Average fuel consumption [kg/h]	1,9	2,6	3,3	1,7
Maximum log length [mm]	250	350	350	250
Glass dimensions [mm]	390x540	540x540	880x540	207x316
External dimensions [mm]	492x938x400	647x938x400	982x938x400	385x897x350
Flue diameter [mm]	150	150	150	150
Inlet diameter [mm]	100	100	100	-
Weight [kg]	112	140	194	84
Energy class	A+	A+	A+	A

THE SPECIFICATION USED IN THE CATALOG:



Nominal power



Heating load range



Thermal efficiency



Area of inlet grilles



Area of outlet grilles



Dimensions



www.hitze.pl



HITZE Natural Heating



HITZE_Natural_Heating



HITZE Natural Heating

STALKO

spółka z ograniczoną odpowiedzialnością
spółka komandytowa (dawniej HITZE sp. z o.o.)

ul. Solec 24/253

00-403 Warszawa, POLAND

Office
Gdyńska 32
26-600 Radom
POLAND



+48 48 380 18 98

+48 800 88 00 30



handlowy@hitze.pl
export@hitze.pl

VAT PL9482603545

REGON 361379132

Reg. No. 0000836475

