



HITZE
PRODUCENT KOMINKÓW

SYSTEM CUSTOM

ALBERO

WKŁADY KOMINKOWE
POWIETRZNE

Dołącz do grona tych, *którzy wybrali dobrze.*

Hitze to nowoczesna marka ekologicznych wkładów kominkowych oraz pieców wolnostojących. Od ponad 20 lat **specjalizujemy się w urządzeniach opalanych drewnem**. Nasza siedziba jak i całość produkcji znajdują się w Polsce, jednak naszych przedstawicieli znajdziecie obecnie **w ponad 35 krajach** Europy, Afryki oraz Azji.

Dynamiczny rozwój w ciągu ostatnich 5 lat ugruntował naszą pozycję w segmencie produktów o podwyższonej jakości przy zachowaniu **konkurencyjnych cen**.

ALBERO SYSTEM CUSTOM

34
modele

4,5 kW

ZAKRES MOCY REGULOWANEJ

32,5kW

Linia ALBERO wyróżnia się lekką i nowoczesną formą, która doskonale wkomponuje się w każdą przestrzeń mieszkalną i użytkową. Składa się z **sześciu serii kominków** różniących się nominalną mocą grzewczą (9, 11, 14, 16, 19 i 25 kW), wizją ognia (prostą lub narożną) oraz sposobem otwierania drzwiczek (unoszone do góry typu „gilotyna” lub tradycyjnie otwierane do boku).

Wkłady wyposażone są w dolot powietrza z regulowaną przepustnicą oraz nóżki pozwalające na optymalne wypoziomowanie. Wnętrze kominków wyłożone jest wkładem z betonu ceramicznego odpornego na temperaturę do 1000°C, który akumuluje ciepło w komorze spalania. Kurtyna powietrzna ogranicza osadzanie sadzy na szybie ze szkła ceramicznego, a system dopalania spalin redukuje emisję szkodliwych substancji do środowiska oraz zwiększa oszczędność palenia. Specjalnie zaprojektowana **wentylowana konstrukcja klamki** zapewnia komfort użytkowania, a rama drzwi wykonana z profilu o podwyższonej sztywności gwarantuje stabilność i wytrzymałość drzwi. W modelach z prostą szybą frontową można zmieniać kierunek otwierania drzwi.



Kurtyna powietrzna
Ogranicza osadzanie sadzy na szybie w kominku, zapewniając efekt „czystej szyby”.

Klasyczna sześciokątna komora spalania
Zmniejszona kubatura paleniska przekłada się na wyższą temperaturę spalania.

Stalowe drzwi
Wykonane z profilu o podwyższonej sztywności gwarantującego szczelność i wytrzymałość drzwi.

Żaroodporne szkło ceramiczne
Odporne na temperaturę pracy do 800°C, opcjonalnie dostępna **szyba DECOR** oraz przeszklenie podwójne.

Dolot powietrza ø125 / 150 mm
Regulowana przepustnica płynnie steruje przepływem powietrza w kominku (1 dźwignia).



Czopuch ø180 / 200 / 220 / 250 mm

Gwarantuje szczelne połączenie kominka z kanałem kominowym, zapewnia prawidłowe spalanie w kominku oraz rozszerza obszar wymiany ciepła.

Opłomki

Zwiększają obszar akumulacji i wymiany ciepła. (od 3 do 6 w zależności od modelu).

Deflektor

Optymalizuje proces spalania poprzez podwyższenie temperatury wewnątrz komory.

System dopalania spalin

Zwiększa ilość energii cieplnej, redukuje emisję szkodliwych substancji do środowiska oraz zwiększa oszczędność opału.

Wkład z betonu akumulacyjnego

Skupia ciepło i jest odporny na temperaturę do 1000°C.

Ruszt i pojemnik na popiół

Ułatwia usuwanie popiołu oraz gromadzi odpady po spalonym drewnie.*

* Model AL120x43 jest paleniskiem bezrusztowym

Regulowane nóżki w zakresie 4 cm

Pozwalają na pewne i stabilne ustawienie wkładu kominkowego.
OPCJA DODATKOWA:
podwyższenie nożek w wysokości +10 cm z regulacją +/- od 3 do 5 cm.

ALBERO 9

SYSTEM CUSTOM



Albero AL9S.H

standardowy poziomy

- 9,0 kW
- 4,5 - 12,0 kW
- 78 %
- 360-590 cm²
- 630-720 cm²

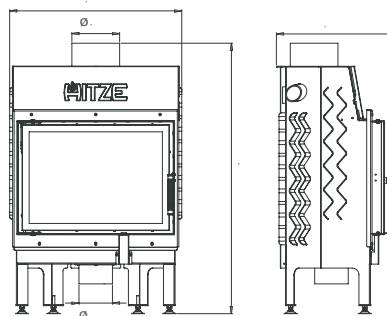

Albero AL9S.V

standardowy pionowy

- 9,0 kW
- 4,5 - 12,0 kW
- 78 %
- 360-590 cm²
- 630-720 cm²

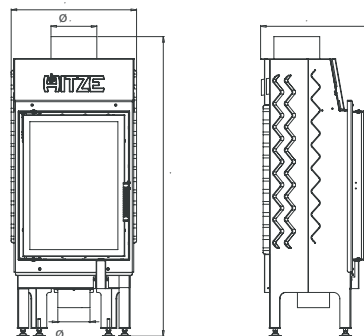

Albero AL9L.H

lewy poziomy

- 9,0 kW
- 4,5 - 12,0 kW
- 78 %
- 360-590 cm²
- 630-720 cm²

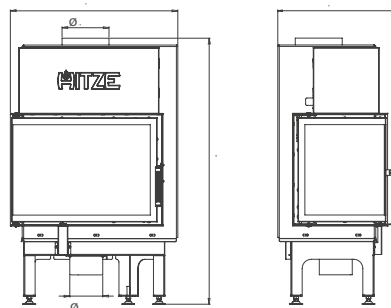

Albero AL9R.H

prawy poziomy



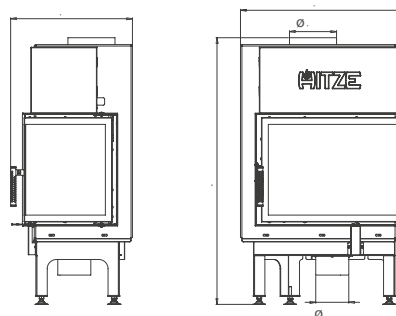

- 9,0 kW
- 4,5 - 12,0 kW
- 78%
- 360-590 cm²
- 630-720 cm²





Albero AL9G.H

gilotyna poziomy



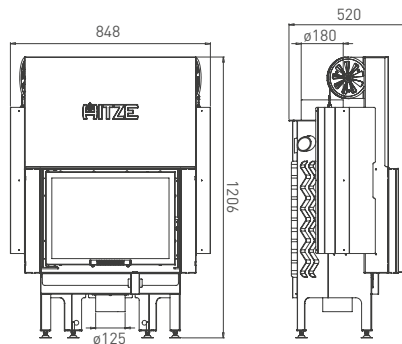

-  9,0 kW
-  4,5 - 12,0 kW
-  78 %
-  360-590 cm²
-  630-720 cm²

A



Albero AL9LG.H

lewy gilotyna poziomy



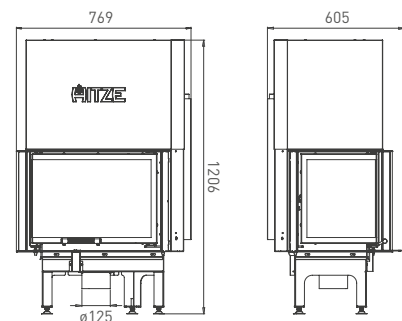

-  9,0 kW
-  4,5 - 12,0 kW
-  78 %
-  360-590 cm²
-  630-720 cm²

A



Albero AL9RG.H

prawy gilotyna poziomy

-  9,0 kW
-  4,5 - 12,0 kW
-  78%
-  360-590 cm²
-  630-720 cm²

A

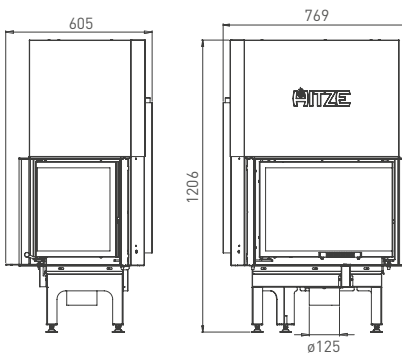

ALBERO 11

SYSTEM CUSTOM



Albero AL11S.H

standardowy poziomy

- 11,0 kW
- 5,5 - 14,0 kW
- 83 %
- 440-720 cm²
- 770-880 cm²

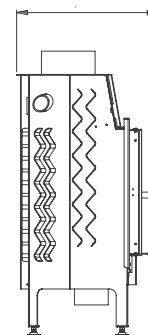
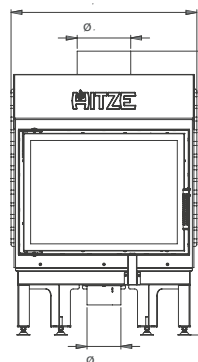

Albero AL11S.V

standardowy pionowy

- 11,0 kW
- 5,5 - 14,0 kW
- 84 %
- 440-720 cm²
- 770-880 cm²

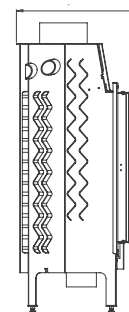
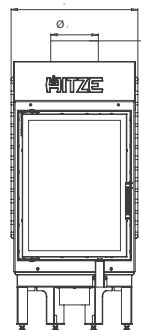

Albero AL11L.H

lewy poziomy

- 11,0 kW
- 5,5 - 14,0 kW
- 83 %
- 440-720 cm²
- 770-880 cm²

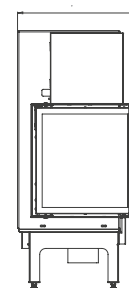
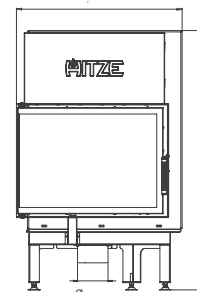

Albero AL11R.H

prawy poziomy



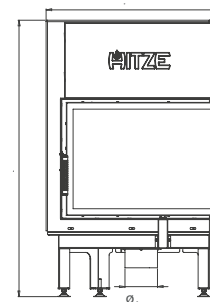
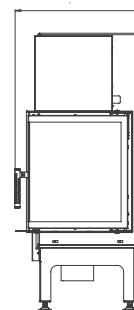

- 11,0 kW
- 5,5 - 14,0 kW
- 83 %
- 440-720 cm²
- 770-880 cm²





Albero AL11G.H

gilotyna poziomy



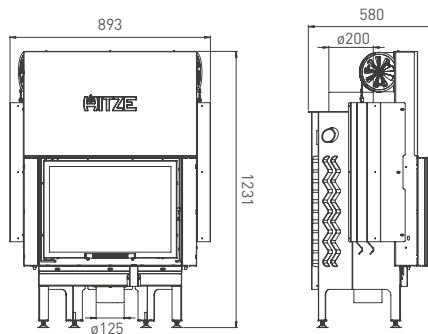

-  11,0 kW
-  5,5 - 14,0 kW
-  83 %
-  440-720 cm²
-  770-880 cm²

A⁺



Albero AL11LG.H

lewy gilotyna poziomy



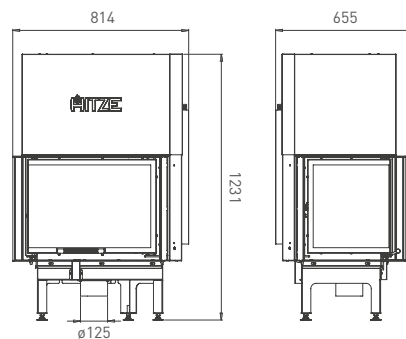

-  11,0 kW
-  5,5 - 14,0 kW
-  83 %
-  440-720 cm²
-  770-880 cm²

A⁺



Albero AL11RG.H

prawy gilotyna poziomy

-  11,0 kW
-  5,5 - 14,0 kW
-  83 %
-  440-720 cm²
-  770-880 cm²

A⁺

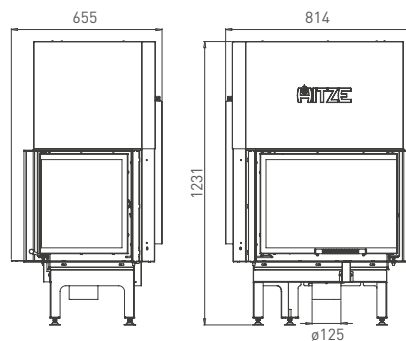

ALBERO 14

SYSTEM CUSTOM



Albero AL14S.H

standardowy poziomy

- 14,0 kW
- 7,0 - 18,0 kW
- 83 %
- 560-910 cm²
- 980-1120 cm³

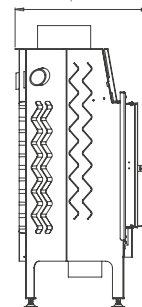
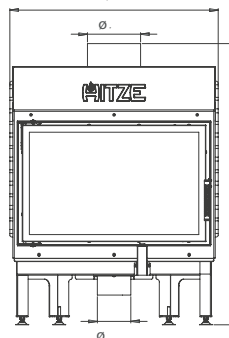

Albero AL14S.V

standardowy pionowy

- 14,0 kW
- 7,0 - 18,0 kW
- 83 %
- 560-910 cm²
- 980-1120 cm³

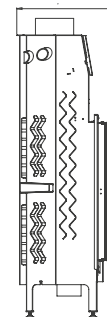
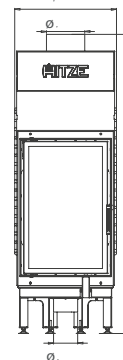

Albero AL14L.H

lewy poziomy

- 14,0 kW
- 7,0 - 18,0 kW
- 83 %
- 560-910 cm²
- 980-1120 cm³

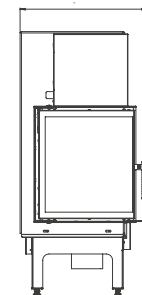
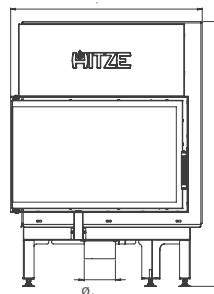

Albero AL14R.H

prawy poziomy



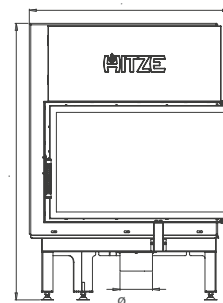
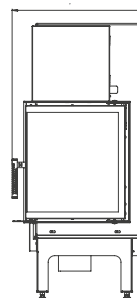

- 14,0 kW
- 7,0 - 18,0 kW
- 83 %
- 560-910 cm²
- 980-1120 cm³





Albero AL14G.H

gilotyna poziomy



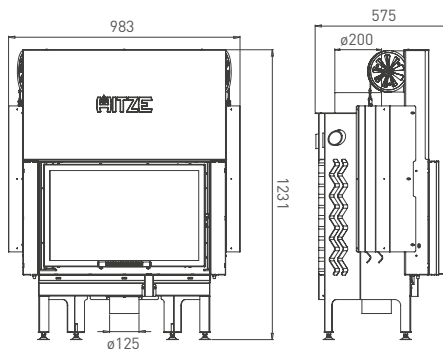

-  14,0 kW
-  7,0 - 18,0 kW
-  83 %
-  560-910 cm²
-  980-1120 cm²

A⁺



Albero AL14LG.H

lewy gilotyna poziomy



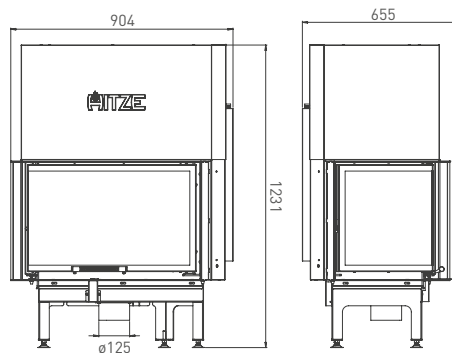

-  14,0 kW
-  7,0 - 18,0 kW
-  83 %
-  560-910 cm²
-  980-1120 cm²

A⁺



Albero AL14RG.H

prawy gilotyna poziomy

-  14,0 kW
-  7,0 - 18,0 kW
-  83 %
-  560-910 cm²
-  980-1120 cm²

A⁺

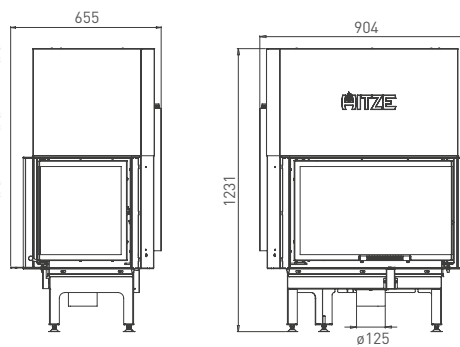





ALBERO 16

SYSTEM CUSTOM



Albero AL16S.H



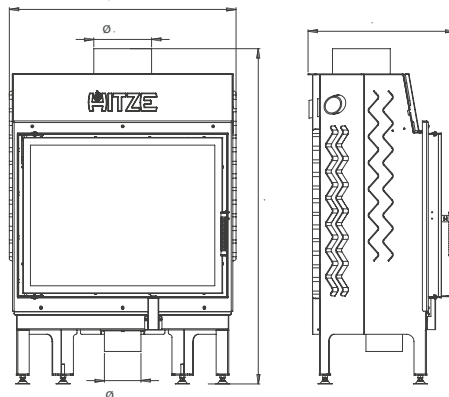

standardowy poziomy

-  16,0 kW
-  8,0 - 20,0 kW
-  80 %
-  640-1140 cm²
-  1120-1280 cm²



Albero AL16L.H



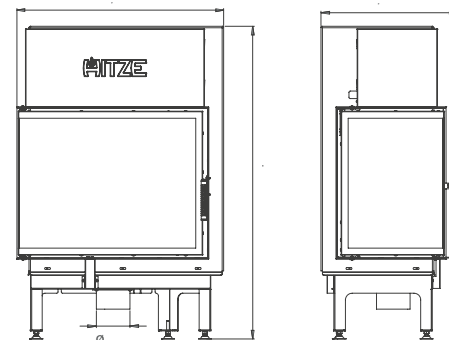

lewy poziomy

-  16,0 kW
-  8,0 - 20,0 kW
-  80 %
-  640-1040 cm²
-  1120-1280 cm²



Albero AL16R.H

prawy poziomy



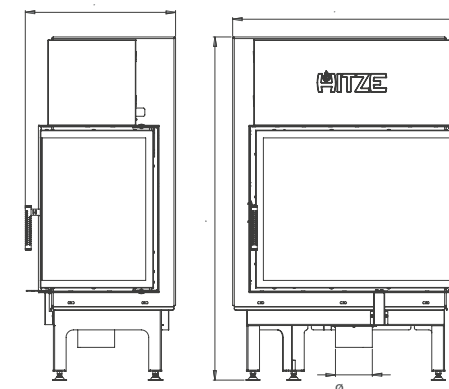

-  16,0 kW
-  8,0 - 20,0 kW
-  80 %
-  640-1040 cm²
-  1120-1280 cm²





Albero AL16G.H

gilotylna poziomy



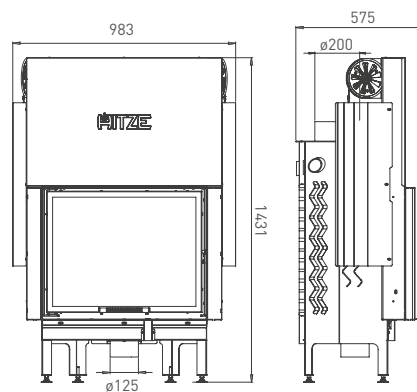

-  16,0 kW
-  8,0 - 20,0 kW
-  80 %
-  640-1040 cm²
-  1120-1280 cm²

A+



Albero AL16LG.H

lewy gilotylna poziomy



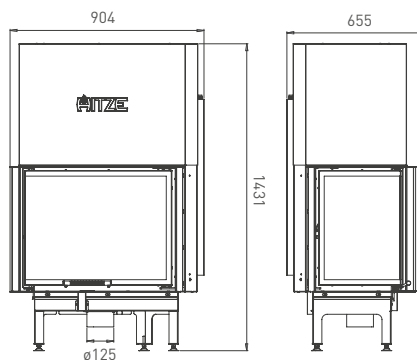

-  16,0 kW
-  8,0 - 20,0 kW
-  80 %
-  640-1040 cm²
-  1120-1280 cm²

A+



Albero AL16RG.H

prawy gilotylna poziomy

-  16,0 kW
-  8,0 - 20,0 kW
-  80 %
-  640-1040 cm²
-  1120-1280 cm²

A+

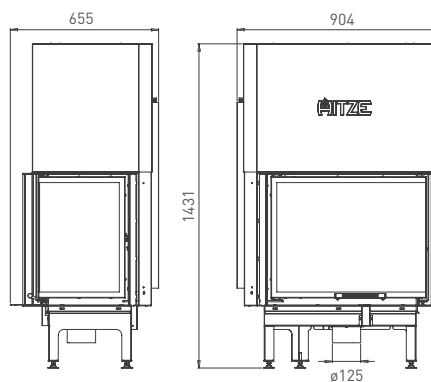





ALBERO 19

SYSTEM CUSTOM



Albero AL19S.H



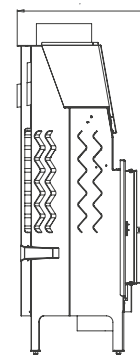
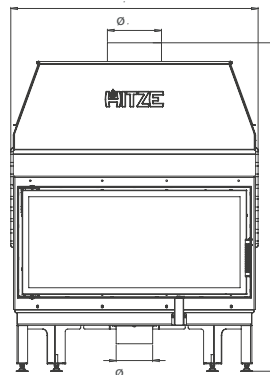

standardowy poziomy

-  19,0 kW
-  9,5 - 24,0 kW
-  81 %
-  760-1240 cm²
-  1330-1520 cm²



Albero AL19L.H



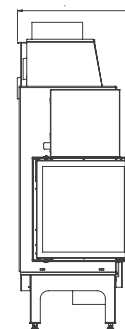
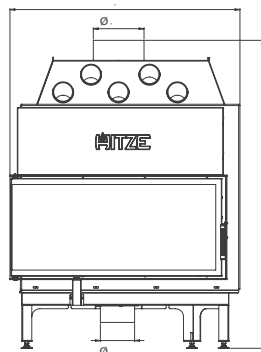

lewy poziomy

-  19,0 kW
-  9,5 - 24,0 kW
-  81 %
-  760-1240 cm²
-  1330-1520 cm²



Albero AL19R.H

prawy poziomy



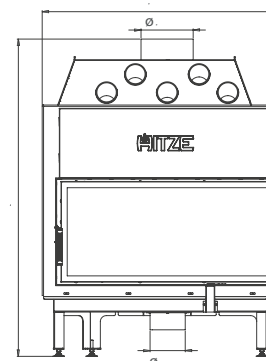
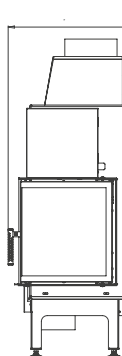

-  19,0 kW
-  9,5 - 24,0 kW
-  81 %
-  760-1240 cm²
-  1330-1520 cm²





Albero AL19G.H

gilotyna poziomy



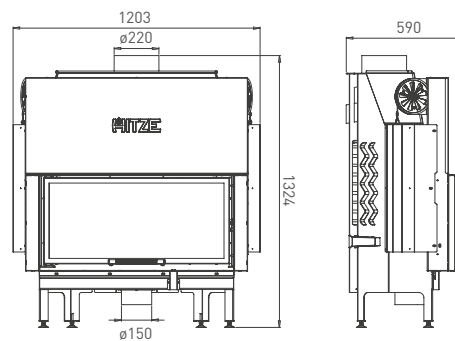

-  19,0 kW
-  9,5 - 24,0 kW
-  81 %
-  760-1240 cm²
-  1330-1520 cm²

A+



Albero AL19LG.H

lewy gilotyna poziomy



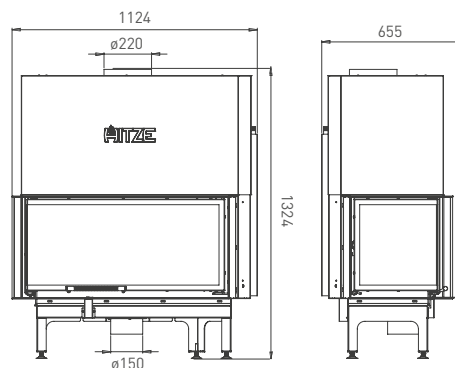

-  19,0 kW
-  9,5 - 24,0 kW
-  81 %
-  760-1240 cm²
-  1330-1520 cm²

A+



Albero AL19RG.H

prawy gilotyna poziomy

-  19,0 kW
-  9,5 - 24,0 kW
-  81 %
-  760-1240 cm²
-  1330-1520 cm²



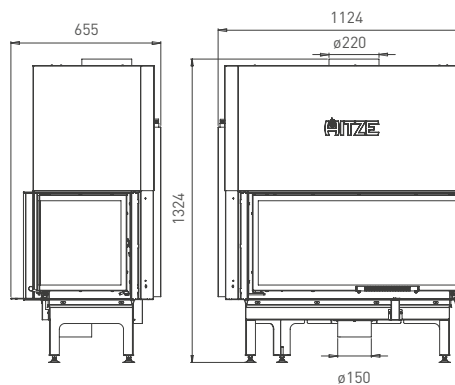

A+





Albero AL120x43G.H

gilotyna poziomy

 kW	25,0 kW
 kW	12,5 - 32,5 kW
	80 %
	1000-1630 cm ²
	1750-2000 cm ²

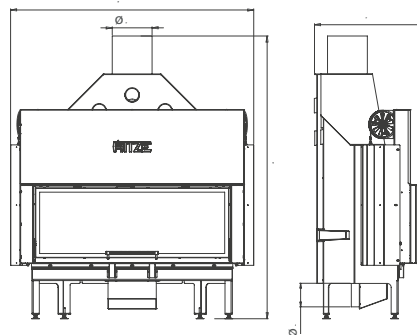

WEJDŹ DO ŚWIATA HITZE.

Świata ciepła z natury.

AKCESORIA INSTALACYJNE:

WYMIENNIKI CIEPŁA



WCPW01.Fi200
WCPW01Fi180
płaszcz wodny

materiał:
stal kotłowa 3 mm

 < 7 kW

 < 7 kW



WCPW01w.Fi200
WCPW01wFi180
płaszcz wodny z węzownią

materiał:
stal kotłowa 3 mm

 < 7 kW

 < 7 kW

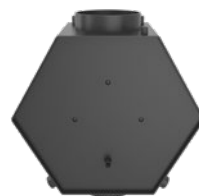

WCPW02.Fi200
płaszcz wodny
z rurkami

materiał:
stal kotłowa 4 mm

 < 10 kW



WCPP01.Fi200
WCPP01Fi180
wymienNIK powietrzny

materiał:
stal kotłowa 3 mm

 < 7 kW

 < 7 kW

ZESTAWY AKUMULACYJNE

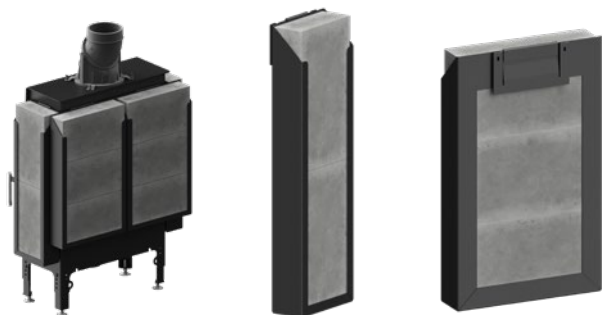

Dla linii:
ALBERO, ALBERO AQUASYSTEM, ARDENTE, STMA

Waga bloczka: 14,5 kg

DODATKOWE NÓŻKI



Dla linii:
ALBERO, ALBERO AQUASYSTEM, STMA, ARDENTE

KRATKI KOMINKOWE

DECCO

Dostępne w różnych kolorach i rozmiarach.
Materiał: stal o grubości 1,5 mm
Ramka montażowa w zestawie

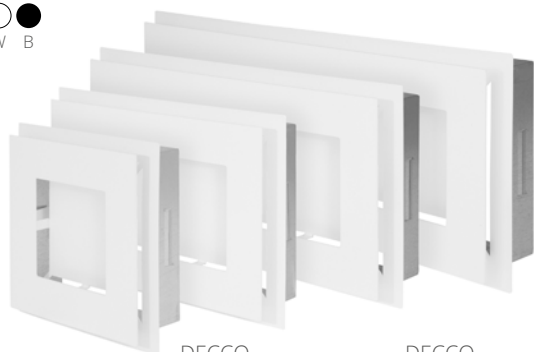

DECCO
rozmiar: 20 x 20 cm
KDC-20x20-W

DECCO
rozmiar: 20 x 30 cm
KDC-20x30-W

DECCO
rozmiar: 20 x 40 cm
KDC-20x40-W

DECCO
rozmiar: 20 x 50 cm
KDC-20x50-W

SLIM

Dostępne w różnych kształtach i rozmiarach.
Kształty: proste i narożne
Materiał: stal o grubości 1,5 mm



SLIM INOX

Dostępne w różnych kształtach i rozmiarach.
Kolory podstawy: czarny
Wykończenie: stal nierdzewna szlifowana
Kształty: proste i narożne
Materiał: stal o grubości 1,5 mm

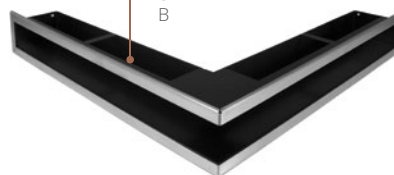

PERSONALIZACJA KOMINKA

KLAMKI STANDARDOWE



INOX VENT



INOX VENT
PORTAL



BLACK VENT



BLACK VENT
PORTAL



BLACK BASIC

KLAMKI GILOTYNOWE (dostępne w 5 rozmiarach)



INOX VENT G



BLACK VENT G



BLACK MINIMAL G

MASKOWNICE

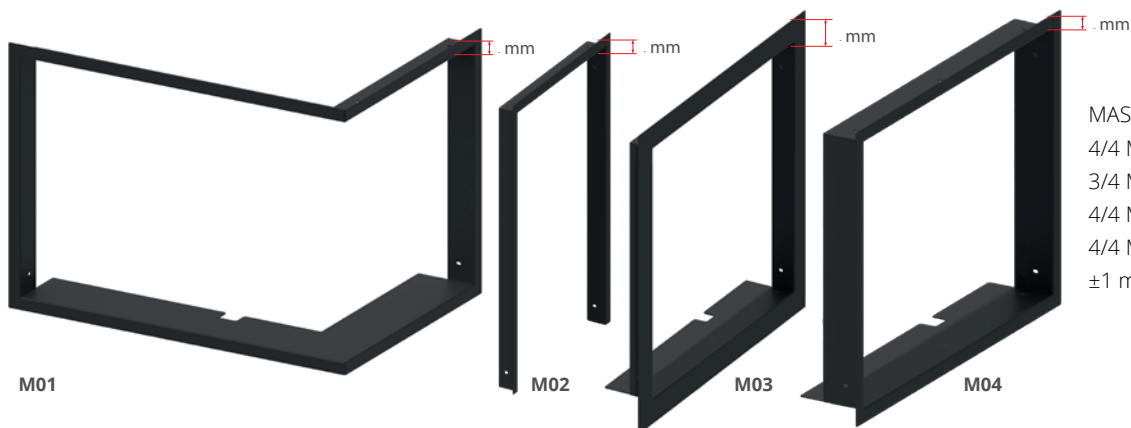

MASKOWNICE:
4/4 M01 - 25 mm
3/4 M02 - 25 mm
4/4 M03 - 50 mm
4/4 M04 - 25 mm / głębokość 79 mm*
±1 mm w zależności od modelu

PODSTAWY SZKLANE



PODSTAWA 01
Wymiary (mm) 515 x 350
PODSTAWA 02
Wymiary (mm) 1067 x 1260
Materiał: szkło hartowane

BIOWKŁADKI

CZARNE WYŁOŻENIE CERAMICZNE

dostępne dla wszystkich modeli



WZORY PRZESZKLENIA DECOR:

wzór DECOR **Elegance**





Dane techniczne

ALBERO 9

ALBERO 9	AL9S.H	AL9S.V	AL9G.H	AL9L.H/R.H	AL9LG.H/RG.H
Moc nominalna [kW]	9,0	9,0	9,0	9,0	9,0
Zakres obciążenia grzewczego [kW]	4,5-12,0	4,5-12,0	4,5-12,0	4,5-12,0	4,5-12,0
Sprawność cieplna [%]	78	78	78	78	78
Emisja CO (przy 13%O ₂) [g/m ³]	0,818	1,029	0,818	0,818	0,818
Emisja CO (przy 13%O ₂) [%]	0,0654	0,082	0,0654	0,0654	0,0654
Emisja pyłków [g/m ³]	0,036	0,030	0,036	0,036	0,036
Średnie zużycie paliwa [kg/h]	3	3	3	3	3
Zalecane pole czynne krater wylotowych [cm ²]	630-720	630-720	630-720	630-720	630-720
Zalecane pole czynne krater wlotowych [cm ²]	360-590	360-590	360-590	360-590	360-590
Wymiary szyby [mm]	545x390	390x545	545x390	545x390x325	545x390x325
Wymiary zewnętrzne [mm]	642x1009x448	487x1164x446	848x1206x520	636x1009x443	769x1206x605
Średnica czopucha [mm]	180	180	180	180	180
Średnica dolotu [mm]	125	125	125	125	125
Maksymalna długość polan [mm]	350	300	350	350	350
Masa wkładu [kg]	112	110	160	112	164
Maskownica 4/4	FAL9S.H-M01	FAL9S.V-M01	FAL9G.H-M01	FAL9L.H-M01 FAL9R.H-M01	FAL9LG.H-M01 FAL9RG.H-M01
Rama portalowa	FAL9S.H-RP01	FAL9S.V-RP01	FAL9G.H-RP01	-	-
Współczynnik efektywności	104,1	104,1	104,1	104,1	104,1
Klasa energetyczna	A	A	A	A	A

ALBERO 11

ALBERO 11	AL11S.H	AL11S.V	AL11G.H	AL11L.H/R.H	AL11LG.H/RG.H
Moc nominalna [kW]	11,0	11,0	11,0	11,0	11,0
Zakres obciążenia grzewczego [kW]	5,5-14,0	5,5-14,0	5,5-14,0	5,5-14,0	5,5-14,0
Sprawność cieplna [%]	83	84	83	83	83
Emisja CO (przy 13%O ₂) [g/m ³]	1,243	1,205	1,243	1,243	1,243
Emisja CO (przy 13%O ₂) [%]	0,0994	0,0964	0,0994	0,0994	0,0994
Emisja pyłków [g/m ³]	0,038	0,031	0,038	0,038	0,031
Średnie zużycie paliwa [kg/h]	3	3	3	3	3
Zalecane pole czynne krater wylotowych [cm ²]	770-880	770-880	770-880	770-880	770-880
Zalecane pole czynne krater wlotowych [cm ²]	440-720	440-720	440-720	440-720	440-720
Wymiary szyby [mm]	590x430	430x590	590x430	590x430x375	590x430x375
Wymiary zewnętrzne [mm]	687x1064x506	527x1209x511	893x1231x580	679x1064x510	814x1231x655
Średnica czopucha [mm]	200	200	200	200	200
Średnica dolotu [mm]	125	125	125	125	125
Maksymalna długość polan [mm]	350	300	350	350	350
Masa wkładu [kg]	132	127	184	132	183
Maskownica 4/4	FAL11S.H-M01	FAL11S.V-M01	FAL11G.H-M01	FAL11L.H-M01 FAL11R.H-M01	FAL11LG.H-M01 FAL11RG.H-M01
Rama portalowa	FAL11S.H-RP01	FAL11S.V-RP01	FAL11G.H-RP01	-	-
Współczynnik efektywności	111,4	112,8	111,4	111,4	111,4
Klasa energetyczna	A ⁺	A ⁺	A ⁺	A ⁺	A ⁺

ALBERO 14

ALBERO 14	AL14S.H	AL14S.V	AL14G.H	AL14L.H/R.H	AL14LG.H/RG.H
Moc nominalna [kW]	14,0	14,0	14,0	14,0	14,0
Zakres obciążenia grzewczego [kW]	7,0-18,0	7,0-18,0	7,0-18,0	7,0-18,0	7,0-18,0
Sprawność cieplna [%]	83	84	83	83	83
Emisja CO (przy 13%O ₂) [g/m ³]	0,845	1,2	0,845	0,845	0,845
Emisja CO (przy 13%O ₂) [%]	0,0676	0,0961	0,0676	0,0676	0,0676
Emisja pyłków [g/m ³]	0,032	0,038	0,032	0,032	0,032
Średnie zużycie paliwa [kg/h]	4	4	4	4	4
Zalecane pole czynne krater wylotowych [cm ²]	980-1120	980-1120	980-1120	980-1120	980-1120
Zalecane pole czynne krater wlotowych [cm ²]	560-910	560-910	560-910	560-910	560-910
Wymiary szyby [mm]	680x430	680x430	680x430	680x430x375	680x430x375
Wymiary zewnętrzne [mm]	777x1065x501	527x1549x511	983x1231x575	769x1065x510	904x1231x655
Średnica czopucha [mm]	200	200	200	200	200
Średnica dołotu [mm]	125	125	125	125	125
Maksymalna długość polan [mm]	500	500	500	500	500
Masa wkładu [kg]	150	150	200	153	215
Maskownica 4/4	FAL14S.H-M01	FAL14S.V-M01	FAL14G.H-M01	FAL11L.H-M01 FAL11R.H-M01	FAL11LG.H-M01 FAL11RG.H-M01
Rama portalowa	FAL14S.H-RP01	FAL14S.V-RP01	FAL14G.H-RP01	-	-
Współczynnik efektywności	111,4	111,4	111,4	111,4	111,4
Klasa energetyczna	A ⁺	A ⁺	A ⁺	A ⁺	A ⁺

ALBERO 16

ALBERO 16	AL16S.H	AL16G.H	AL16L.H/R.H	AL16LG.H/RG.H
Moc nominalna [kW]	16,0	16,0	16,0	16,0
Zakres obciążenia grzewczego [kW]	8,0-20,0	8,0-20,0	8,0-20,0	8,0-20,0
Sprawność cieplna [%]	80	80	80	80
Emisja CO (przy 13%O ₂) [g/m ³]	0,786	0,786	0,786	0,786
Emisja CO (przy 13%O ₂) [%]	0,0629	0,0629	0,0629	0,0629
Emisja pyłków [g/m ³]	0,033	0,033	0,033	0,033
Średnie zużycie paliwa [kg/h]	5	5	5	5
Zalecane pole czynne krater wylotowych [cm ²]	1120-1280	1120-1280	1120-1280	1120-1280
Zalecane pole czynne krater wlotowych [cm ²]	640-1040	640-1040	640-1040	640-1040
Wymiary szyby [mm]	680x530	680x530	680x530x375	680x530x375
Wymiary zewnętrzne [mm]	777x1165x512	983x1431x575	769x1165x510	904x1431x655
Średnica czopucha [mm]	200	200	200	200
Średnica dołotu [mm]	125	125	125	125
Maksymalna długość polan [mm]	500	500	500	500
Masa wkładu [kg]	162	228	157	217
Maskownica 4/4	FAL16S.H-M01	FAL16G.H-M01	FAL16L.H-M01 FAL16R.H-M01	FAL16LG.H-M01 FAL16RG.H-M01
Rama portalowa	FAL16S.H-RP01	FAL16G.H-RP01	-	-
Współczynnik efektywności	107,0	107,0	107,0	107,0
Klasa energetyczna	A ⁺	A ⁺	A ⁺	A ⁺

ALBERO 19 i 25

ALBERO 19	AL19S.H	AL19G.H	AL19L.H/R.H	AL19LG.H/RG.H	AL120x43G.H
Moc nominalna [kW]	19,0	19,0	19,0	19,0	25,0
Zakres obciążenia grzewczego [kW]	9,5-24,0	9,5-24,0	9,5-24,0	9,5-24,0	12,5-32,5
Sprawność cieplna [%]	81	81	81	81	80
Emisja CO (przy 13%O ₂) [g/m ³]	1,200	1,200	1,200	1,200	1,215
Emisja CO (przy 13%O ₂) [%]	0,096	0,096	0,096	0,096	0,0972
Emisja pyłków [g/m ³]	0,029	0,029	0,029	0,029	0,028
Średnie zużycie paliwa [kg/h]	6	6	6	6	8
Zalecane pole czynne krętek wlotowych [cm ²]	1330-1520	1330-1520	1330-1520	1330-1520	1750-2000
Zalecane pole czynne krętek wlotowych [cm ²]	760-1240	760-1240	760-1240	760-1240	1000-1630
Wymiary szyby [mm]	900x415	900x415	900x415x375	900x415x375	1200x430
Wymiary zewnętrzne [mm]	997x1324x512	1203x1324x590	989x1324x510	1124x1324x655	1503x1760x690
Średnica czopucha [mm]	220	220	220	220	250
Średnica dolotu [mm]	150	150	150	150	150
Maksymalna długość polan [mm]	500	500	500	500	800
Masa wkładu [kg]	183	262	206	275	431
Maskownica 4/4	FAL19S.H-M01	FAL19G.H-M01	FAL16L.H-M01 FAL16R.H-M01	FAL19LG.H-M01 FAL19RG.H-M01	-
Rama portalowa	FAL19S.H-RP01	FAL19G.H-RP01	-	-	-
Współczynnik efektywności	108,5	108,5	108,5	108,5	107,0
Klasa energetyczna	A ⁺	A ⁺	A ⁺	A ⁺	A ⁺

ZNACZENIE UŻYTYCH IKON:



Moc nominalna



Zakres obciążenia grzewczego



Sprawność cieplna



Zalecane pole czynne krętek wlotowych



Zalecane pole czynne krętek wylotowych



Wymiary





www.hitze.pl



HitzeProducentKominków



hitze_producent_kominkow



HITZE Producent Kominków

STALKO
spółka z ograniczoną odpowiedzialnością
spółka komandytowa
ul. Solec 24/253
00-403 Warszawa, POLSKA

Biuro:
Gdyńska 32
26-600 Radom
POLSKA

 +48 48 380 18 98
+48 800 88 00 30

 info@hitze.pl

NIP 9482603545
REGON 361379132
KRS 0000836475

Kolory RAL przedstawione na wizualizacjach produktów mają charakter poglądowy i ich odcienie mogą nieznacznie różnić się od koloru rzeczywistego.

Firma Hitze zastrzega sobie prawo do wprowadzania zmian w parametrach technicznych, wyposażenia i specyfikacji oferowanych produktów. Informacje zawarte w katalogu mają charakter wyłącznie informacyjny. i nie stanowią oferty w rozumieniu kodeksu cywilnego.